

Les axes de symétrie

Colorie les éléments dont l'axe de symétrie est bien tracé.

Fais ensuite un X sur les éléments qui n'ont pas un bon axe de symétrie.

a)

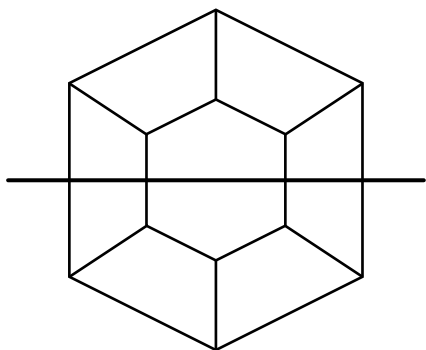

b)

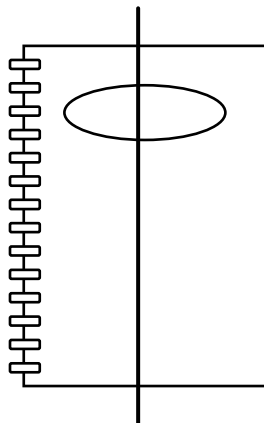

c)

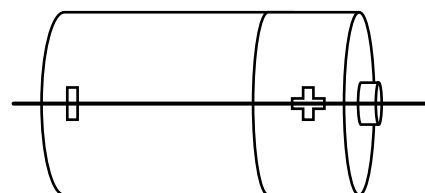

d)

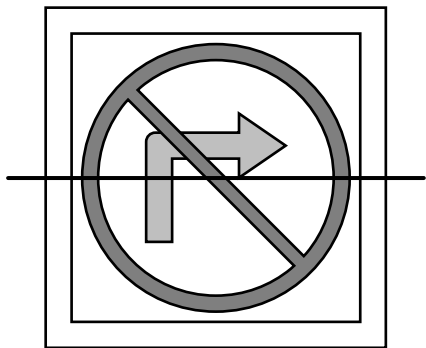

e)

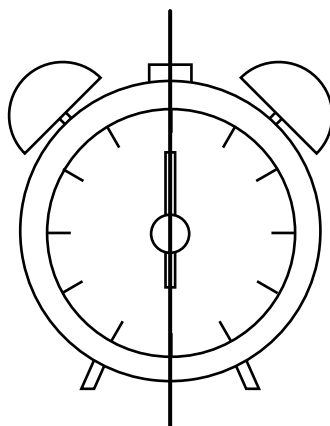

f)

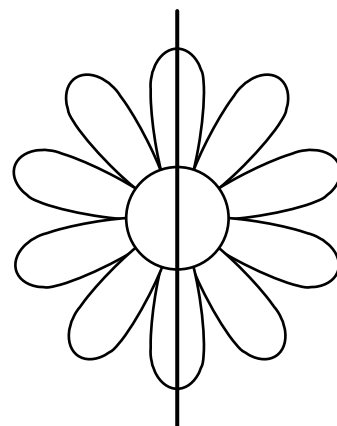

g)



h)

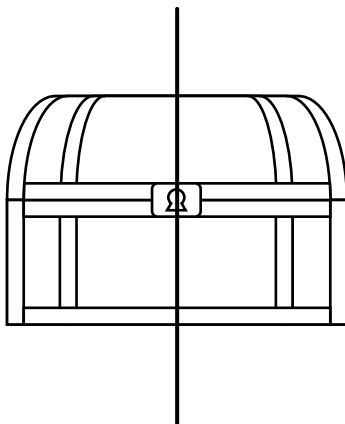

i)

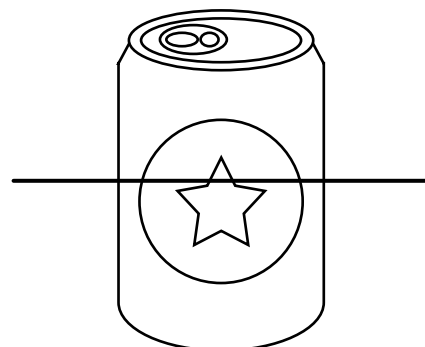

Nom : _____ Date : _____

Les axes de symétrie

Colorie les éléments dont l'axe de symétrie est bien tracé.

Fais ensuite un X sur les éléments qui n'ont pas un bon axe de symétrie.

a)

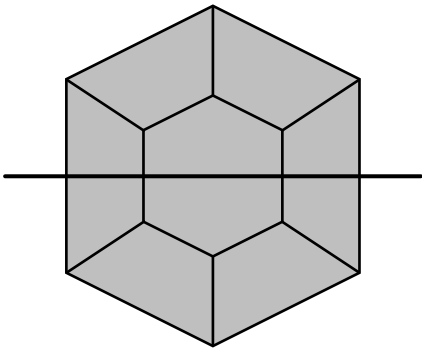

b)

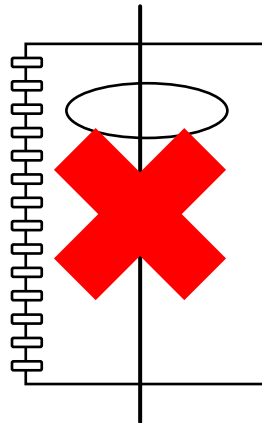

c)

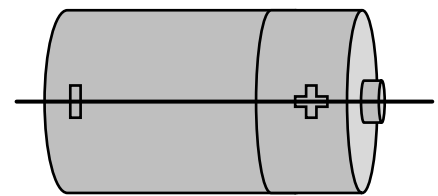

d)

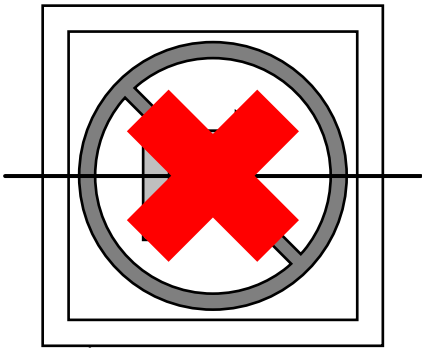

e)

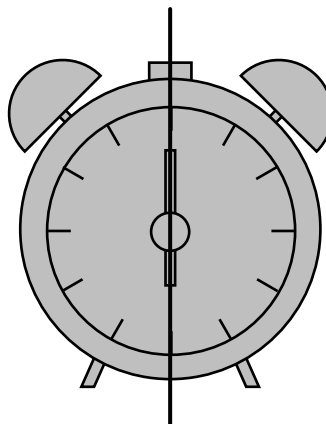

f)

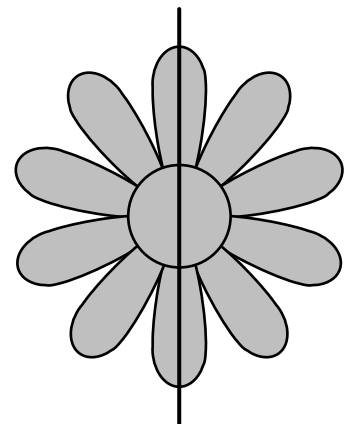

g)



h)

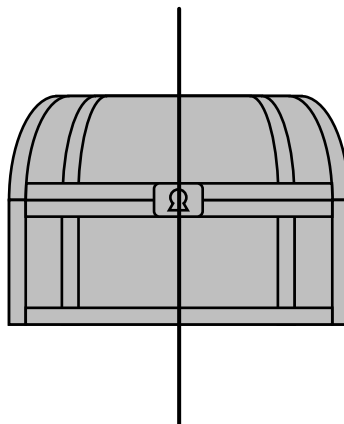

i)

